

VDL Ball valve PVC-U 40 mm glue socket 16bar DN32 grey type EIL (7018363)



VDL Van de Lande

TECHNICAL SPECIFICATIONS

Colour grey

Type EIL

Material PVC-U

Operation lever

Colour lever red

Handle material PVC-U

Housing construction 2-part

Material housing PVC-U

Material seal EPDM

Connection glue socket

Temperature range 0°C - 60°C

Pressure 16 bar

Size 40 mm

DN 32

DIMENSIONS

Ct-1 75 mm

Lb 117 mm

R 106 mm

ØDf 32 mm

ØDi-1 40 mm

ØDi-2 40 mm

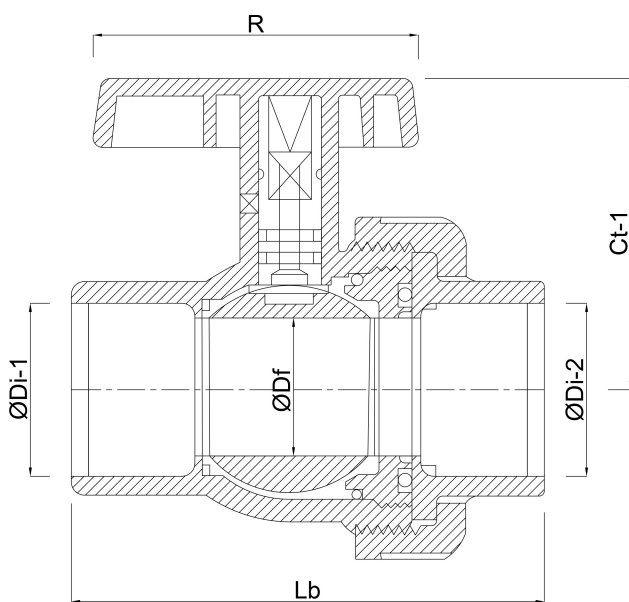

Last modified date: 25/05/2026

Bosta UK Ltd.
Reflection House
Olding Road
Bury St. Edmunds
Suffolk
IP33 3TA
T +44 (0) 1284 716580
E enquiries@bosta.co.uk
<http://www.bosta.com>