

**Profec Flange threaded steel
zinc plated DN15 x 1/2" DIN
flange x female thread DN15
PN10/16 (1080210)**



TECHNICAL SPECIFICATIONS

Material	steel
Surface treatment	zinc plated
Connection	DIN flange x female thread
DIN Standard	DIN 2566
Flange	PN10/16
Size	DN15 x 1/2"
Bolt	M12
DN	15
Diameter	21,3 mm
Outer ø	95 mm
Weight	0.613 kg
Thickness	14 mm
Bolt hole	14 mm
Holes	4

DIMENSIONS

O	14 mm
---	-------

PCD

65 mm

ØDi-1

1/2 "

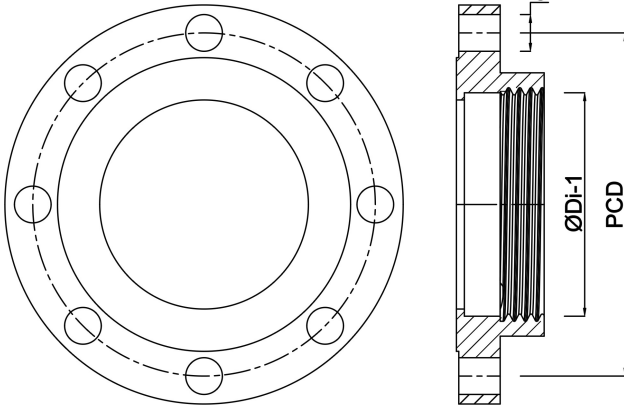

Last modified date: 24/05/2026

Bosta UK Ltd.
Reflection House
Olding Road
Bury St. Edmunds
Suffolk
IP33 3TA
T +44 (0) 1284 716580
E enquiries@bosta.co.uk
<http://www.bosta.com>