

**Profec Flange adaptor ductile  
iron (GGG40) epoxy coating  
110 mm x DN100 ring seal x  
DIN flange 10bar DN100 blue  
PN10/16 type E-KS (0399021)**



# TECHNICAL SPECIFICATIONS

Colour	blue
Type	E-KS
Material	ductile iron (GGG40)
Surface treatment	epoxy coating
Material housing	ductile iron (GGG40)
Material seal	EPDM
Connection	ring seal x DIN flange
DIN Standard	DIN 2576
Flange	PN10/16
Thickness	16 mm
Pressure	10 bar
Holes	8
Size	110 mm x DN100
DN	100
Outer ø	220 mm
Bolt hole	19 mm

# DIMENSIONS

O 19 mm

PCD 180 mm

ØDi-1 110 mm

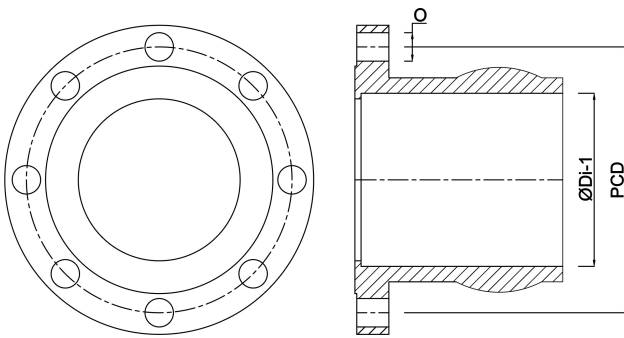

**Last modified date: 23/05/2026**

Bosta UK Ltd.  
Reflection House  
Olding Road  
Bury St. Edmunds  
Suffolk  
IP33 3TA  
T +44 (0) 1284 716580  
E [enquiries@bosta.co.uk](mailto:enquiries@bosta.co.uk)  
<http://www.bosta.com>