

**Profec Flange adaptor PVC-U
DN175 x 200 mm DIN flange x
glue socket 10bar DN175 grey
PN10 (0111053)**



TECHNICAL SPECIFICATIONS

Colour	grey
Material	PVC-U
Connection	DIN flange x glue socket
Size	DN175 x 200 mm
Bolt	M20
DN	175
Flange	PN10
Outer ø	315 mm
Weight	2.345 kg
Length bolt	110 mm
Thickness	30 mm
Pressure	10 bar
Bolt hole	22 mm
Holes	8

DIMENSIONS

O	22 mm
---	-------

PCD 270 mm

ØDi-1 200 mm

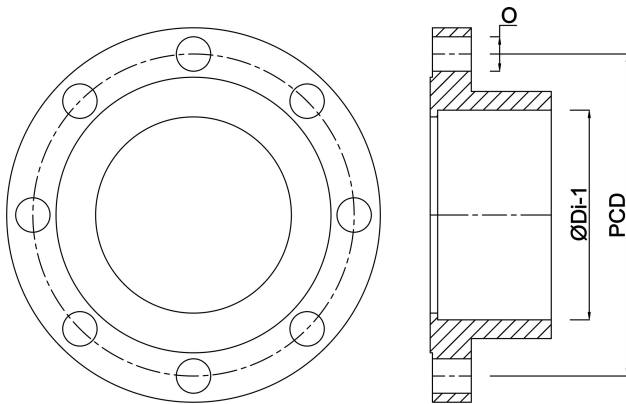

Last modified date: 23/05/2026

Bosta UK Ltd.
Reflection House
Olding Road
Bury St. Edmunds
Suffolk
IP33 3TA
T +44 (0) 1284 716580
E enquiries@bosta.co.uk
<http://www.bosta.com>