

**Profec Swing check valve with
lifting device ductile iron
(GGG40) epoxy coating DN100
DIN flange 16bar DN100 blue
PN10/16 (0402637)**



TECHNICAL SPECIFICATIONS

Colour	blue
Material	ductile iron (GGG40)
Surface treatment	epoxy coating
Material cover	ductile iron
Material housing	ductile iron (GGG40)
Material seal	NBR
Connection	DIN flange
Gasket	NBR
Temperature range	0°C - 80°C
Pressure	16 bar
Capacity	170 m ³ /h
Size	DN100
Length	300 mm
DN	100
Flange	PN10/16
Outer ø	220 mm
PCD	180 mm

DIMENSIONS

Ct-1 110 mm

L 300 mm

PCD 180 mm

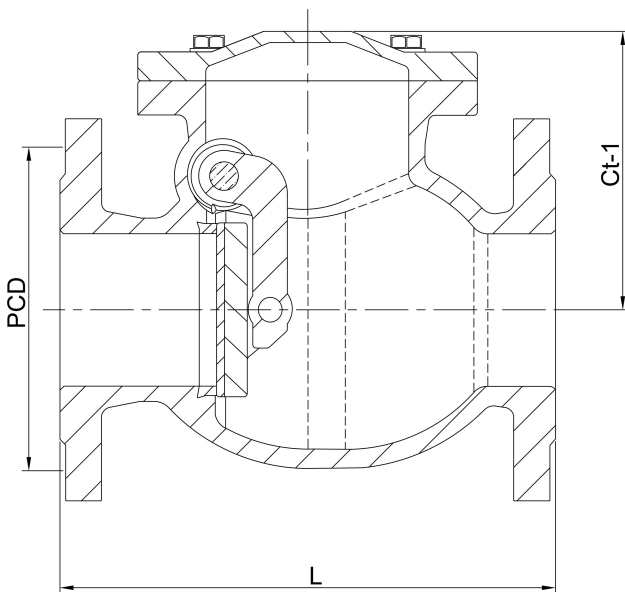

Last modified date: 23/05/2026

Bosta UK Ltd.
Reflection House
Olding Road
Bury St. Edmunds
Suffolk
IP33 3TA
T +44 (0) 1284 716580
E enquiries@bosta.co.uk
<http://www.bosta.com>