

# Flotide Sand filter HDPE 63 mm / 2" metric/imperial glue socket 2,8bar grey type MFS27 (7042926)



**FLOTIDE**

# TECHNICAL SPECIFICATIONS

Colour	grey
Material	HDPE
Connection	metric/imperial glue socket
Pressure	2,8 bar
Max. temp.	50 °C
Type	MFS27
Capacity	18 m <sup>3</sup> /h
Size	63 mm / 2"
Diameter	675 mm
Weight	24.3 kg
Sand	185 kg
Filter area	0.36 m <sup>2</sup>
Max flow rate	18 m <sup>3</sup> /h
Max. pool vol.	101.5 m <sup>3</sup>

## DIMENSIONS

A	946 mm
---	--------

B 26 "

B 26 " inch

B 675 mm

C 613.5 mm

D 527.5 mm

F 590.5 mm

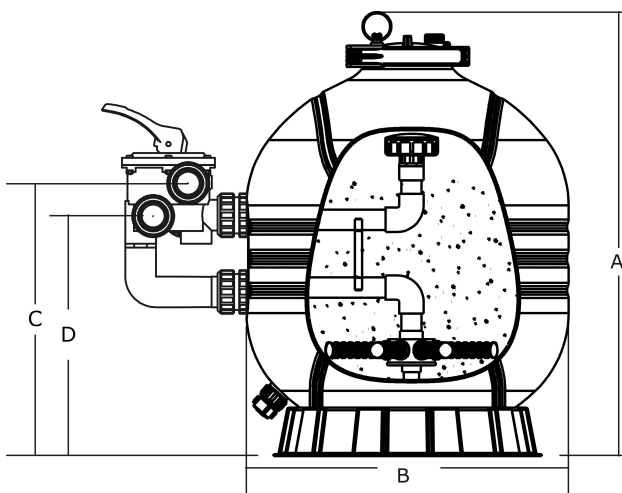

## PRODUCT INFORMATION

Made of premium grade high density polyethylene. The Flotide line offers heavy duty operation and sustains a high working temperature. Only first class virgin high density polyethylene raw materials made by Phillips Chemicals are used in the production of our filters. The unique twist lock is designed for ease of servicing and maintenance of the filter.

- Compact and heavy duty
- Made of high density polyethylene
- Designed for most domestic swimming pools or spa pools

- Easy-to-use bayonet-locked multi-port valve lets you select any of the valve/filter operations with a simple lever-action
- Warranty period: 2 years

**Last modified date: 27/05/2026**

Bosta UK Ltd.  
Reflection House  
Olding Road  
Bury St. Edmunds  
Suffolk  
IP33 3TA  
T +44 (0) 1284 716580  
E [enquiries@bosta.co.uk](mailto:enquiries@bosta.co.uk)  
<http://www.bosta.com>