

**Ball valve PVC-U 1 1/2" female
thread 10bar DN40 grey type
AK (0161514)**



TECHNICAL SPECIFICATIONS

Colour grey

Type AK

Material PVC-U

Operation lever

Colour lever red

Handle material PVC-U

Housing construction 3-part

Material housing PVC-U

Material seal PE/EPDM

Connection female thread

Max. temperature 60 °C

Minimum medium temperature 0 °C
(continuous)

Pressure 10 bar

Size 1 1/2"

DN 40

DIMENSIONS

Ct-1 93 mm

Lb 148 mm

R 62 mm

ØDf 40 mm

ØDi-1 1 1/2 "

ØDi-2 1 1/2 "

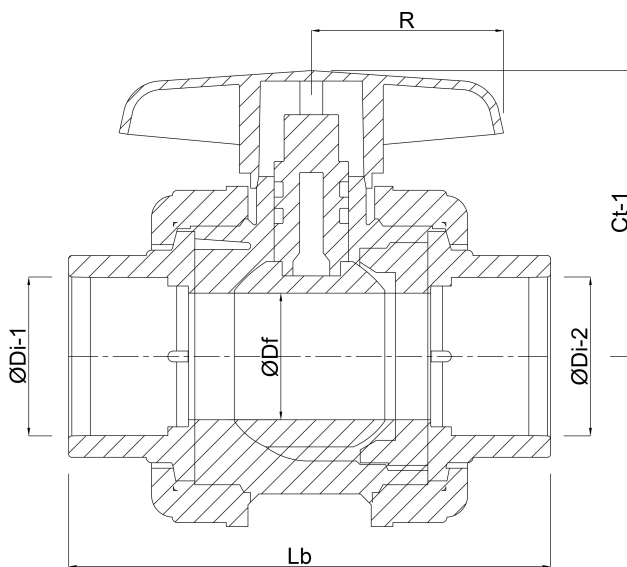

Last modified date: 23/05/2026

Bosta UK Ltd.
Reflection House
Olding Road
Bury St. Edmunds
Suffolk

IP33 3TA
T +44 (0) 1284 716580
E enquiries@bosta.co.uk
<http://www.bosta.com>