

# Profec Ball valve bronze 2" female thread 16bar type 160 (0400281)



# TECHNICAL SPECIFICATIONS

Type	160
Material	bronze
Operation	lever
Colour lever	blue
Handle material	steel
Ball material	hard chrome plated brass
Material housing	bronze
Material seal	PTFE
Connection	female thread
Max. temperature	150 °C
Pressure	16 bar
Size	2"

## DIMENSIONS

Ct-1	95 mm
F-1	21 mm
F-2	21 mm

Lb 96,8 mm

R 150 mm

ØDf 50 mm

ØDi-1 2 "

ØDi-2 2 "

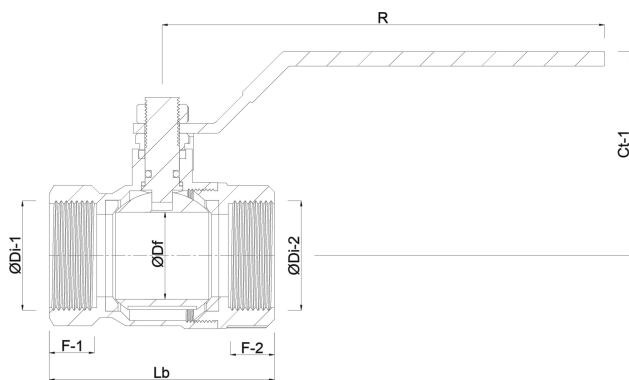

**Last modified date: 23/05/2026**

Bosta UK Ltd.  
Reflection House  
Olding Road  
Bury St. Edmunds  
Suffolk  
IP33 3TA  
T +44 (0) 1284 716580  
E [enquiries@bosta.co.uk](mailto:enquiries@bosta.co.uk)  
<http://www.bosta.com>