

**Flotide Sand filter HDPE 50 mm
/ 1 1/2" metric/imperial glue
socket 2,8bar grey type MFS20
(7042924)**



FLOTIDE

TECHNICAL SPECIFICATIONS

Colour	grey
Material	HDPE
Connection	metric/imperial glue socket
Pressure	2,8 bar
Max. temp.	50 °C
Type	MFS20
Capacity	10 m ³ /h
Size	50 mm / 1 1/2"
Diameter	500 mm
Weight	13 kg
Sand	70 kg
Filter area	0.2 m ²
Max flow rate	10 m ³ /h
Max. pool vol.	52.5 m ³

DIMENSIONS

A	760 mm
---	--------

B 20 "

B 20 " inch

B 500 mm

C 459.3 mm

D 396.3 mm

F 549.3 mm

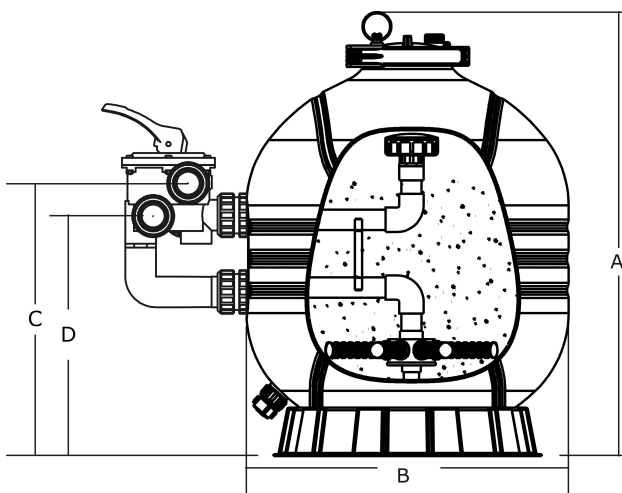

PRODUCT INFORMATION

Made of premium grade high density polyethylene. The Flotide line offers heavy duty operation and sustains a high working temperature. Only first class virgin high density polyethylene raw materials made by Phillips Chemicals are used in the production of our filters. The unique twist lock is designed for ease of servicing and maintenance of the filter.

- Compact and heavy duty
- Made of high density polyethylene
- Designed for most domestic swimming pools or spa pools

- Easy-to-use bayonet-locked multi-port valve lets you select any of the valve/filter operations with a simple lever-action
- Warranty period: 2 years

Last modified date: 27/05/2026

Bosta UK Ltd.
Reflection House
Olding Road
Bury St. Edmunds
Suffolk
IP33 3TA
T +44 (0) 1284 716580
E enquiries@bosta.co.uk
<http://www.bosta.com>