

**Flange stainless steel 316
DN25 x DN25 x 1" DIN flange x
female thread 40bar DN25
PN40 (0080665)**



TECHNICAL SPECIFICATIONS

Material	stainless steel 316
Connection	DIN flange x female thread
DIN Standard	DIN 2566
Size	DN25 x DN25 x 1"
DN	25
Flange	PN40
Diameter	33,7 mm
Outer ø	115 mm
Weight	1.3 kg
Thickness	18 mm
Pressure	40 bar
Bolt hole	14 mm
Holes	4

DIMENSIONS

O	14 mm
PCD	85 mm

ØDi-1

1"

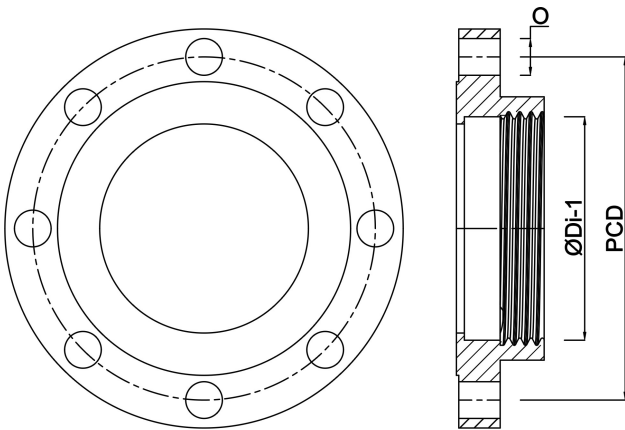

Last modified date: 22/05/2026

Bosta UK Ltd.
Reflection House
Olding Road
Bury St. Edmunds
Suffolk
IP33 3TA
T +44 (0) 1284 716580
E enquiries@bosta.co.uk
<http://www.bosta.com>