

# Profec Ball valve PVC-U 25 mm glue socket 16bar DN25 grey type Safe 600 (0112102)



# TECHNICAL SPECIFICATIONS

Colour grey

Type Safe 600

Material PVC-U

Operation lever

Colour lever red

Handle material PVC-U

Housing construction 3-part

Ball material PVC-U

Material spindle PVC-U

Material housing PVC-U

Material seal hytrel/EPDM

Connection glue socket

Max. temperature 60 °C

Minimum medium temperature 0 °C  
(continuous)

Pressure 16 bar

Size 25 mm

DN

25

## DIMENSIONS

Ct-1

71 mm

Lb

112 mm

R

54 mm

ØDf

25 mm

ØDi-1

25 mm

ØDi-2

25 mm

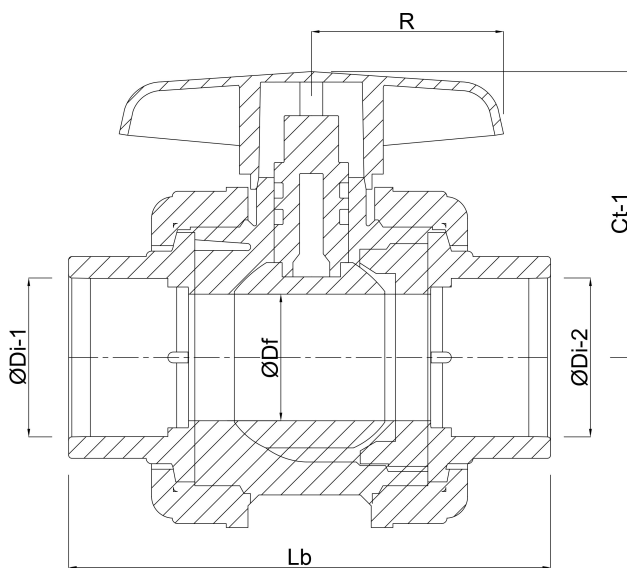

## PRODUCT INFORMATION

With secure ball.

**Last modified date: 23/05/2026**

Bosta UK Ltd.  
Reflection House  
Olding Road  
Bury St. Edmunds  
Suffolk  
IP33 3TA  
T +44 (0) 1284 716580  
E [enquiries@bosta.co.uk](mailto:enquiries@bosta.co.uk)  
<http://www.bosta.com>