

**Profec Flange adaptor PVC-U
DN65 x 75 mm DIN flange x
glue socket 16bar DN65 grey
PN10/16 (0111046)**



TECHNICAL SPECIFICATIONS

Colour	grey
Material	PVC-U
Connection	DIN flange x glue socket
Size	DN65 x 75 mm
Bolt	M16
DN	65
Flange	PN10/16
Outer ø	185 mm
Weight	0.555 kg
Length bolt	90 mm
Thickness	19 mm
Pressure	16 bar
Bolt hole	18 mm
Holes	4

DIMENSIONS

O	18 mm
---	-------

PCD

145 mm

ØDi-1

75 mm

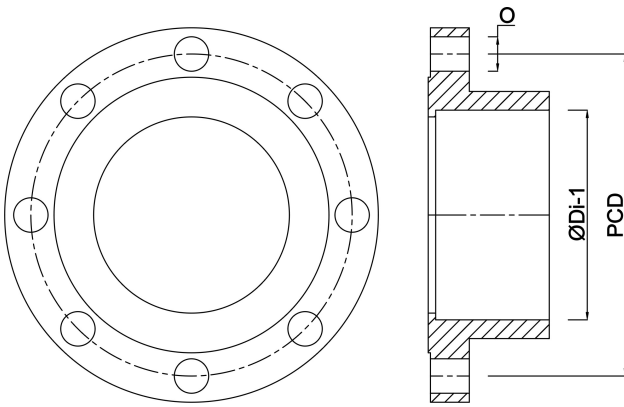

Last modified date: 19/06/2026

Bosta UK Ltd.
Reflection House
Olding Road
Bury St. Edmunds
Suffolk
IP33 3TA
T +44 (0) 1284 716580
E enquiries@bosta.co.uk
<http://www.bosta.com>