

**Profec Flange PVC-U DN50 x 2"**  
**DIN flange x female thread**  
**16bar DN50 grey PN10/16**  
**(0111165)**



# TECHNICAL SPECIFICATIONS

Colour	grey
Material	PVC-U
Connection	DIN flange x female thread
Flange	PN10/16
Pressure	16 bar
Size	DN50 x 2"
DN	50
Outer ø	165 mm
Weight	0.42 kg
Thickness	18 mm
Bolt hole	18 mm
Holes	4

## DIMENSIONS

O	18 mm
PCD	125 mm
ØDi-1	2"

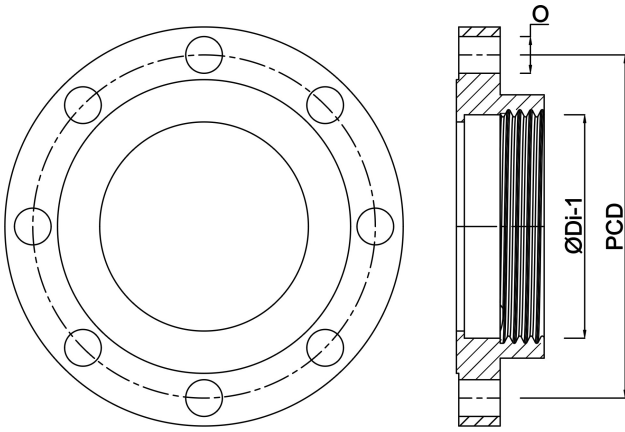

**Last modified date: 23/05/2026**

Bosta UK Ltd.  
Reflection House  
Olding Road  
Bury St. Edmunds  
Suffolk  
IP33 3TA  
T +44 (0) 1284 716580  
E [enquiries@bosta.co.uk](mailto:enquiries@bosta.co.uk)  
<http://www.bosta.com>