

Profec Ball valve PVC-U 50 mm glue socket 16bar DN40 grey type Safe 600 (0112105)



TECHNICAL SPECIFICATIONS

Colour grey

Type Safe 600

Material PVC-U

Operation lever

Colour lever red

Handle material PVC-U

Housing construction 3-part

Ball material PVC-U

Material spindle PVC-U

Material housing PVC-U

Material seal hytrel/EPDM

Connection glue socket

Max. temperature 60 °C

Minimum medium temperature 0 °C
(continuous)

Pressure 16 bar

Size 50 mm

DN

40

DIMENSIONS

Ct-1

93 mm

Lb

157 mm

R

65 mm

ØDf

40 mm

ØDi-1

50 mm

ØDi-2

50 mm

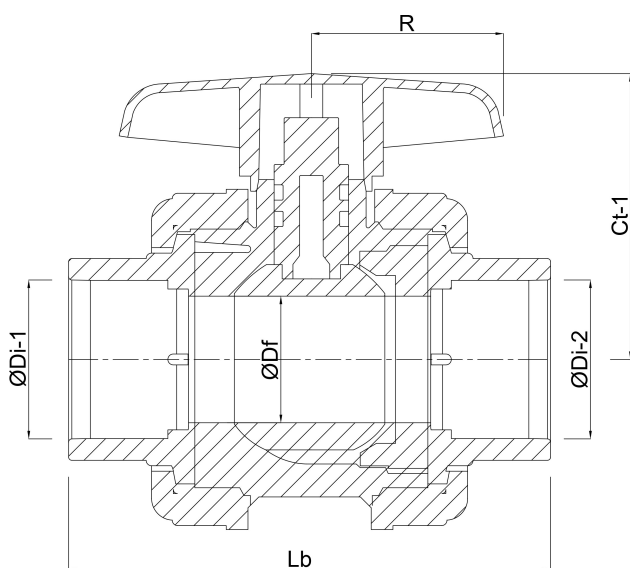

PRODUCT INFORMATION

With secure ball.

Last modified date: 23/05/2026

Bosta UK Ltd.
Reflection House
Olding Road
Bury St. Edmunds
Suffolk
IP33 3TA
T +44 (0) 1284 716580
E enquiries@bosta.co.uk
<http://www.bosta.com>