

**Bocht 90° staal 100 mm x 100
mm x 2,0 mm stomplas**
(0200604)



TECHNISCHE SPECIFICATIES

Materiaal staal

Verbinding stomplas

Wand 2,0 mm

Maat 100 mm

AFMETINGEN

Cb-1 300 mm

Cb-2 300 mm

ØDo-1 100 mm

ØDo-2 100 mm

β 90 °

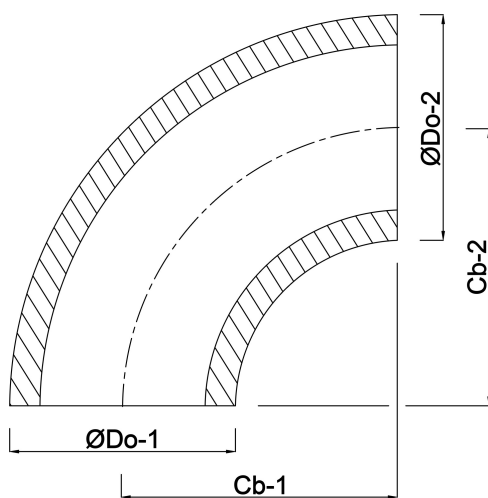

Gegenerereerd op datum: 14-03-2026

<http://www.bosta.com>