

**Profec Nr. 241 Verloopring  
messing 2 1/2" x 1 1/4"  
buitendraad x binnendraad  
20bar (0708862)**



# TECHNISCHE SPECIFICATIES

Materiaal	messing
Verbinding	buitendraad x binnendraad
Fitting nr.	Nr. 241
Maat	2 1/2" x 1 1/4"
Max. temperatuur	80 °C
Werkdruk	20 bar
Max. temp.	80 °C

# AFMETINGEN

L	37 mm
ØDi-1	1 1/4 "
ØDo-2	2 1/2 "

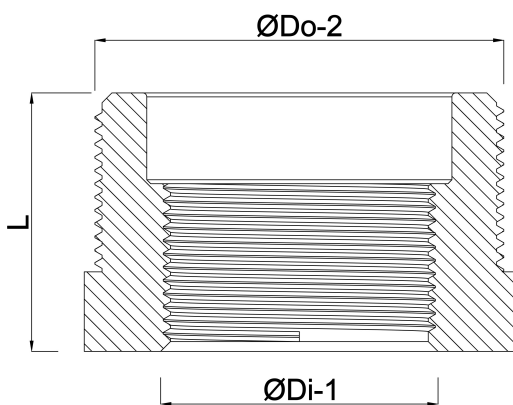

**Gegenerereerd op datum: 13-03-2026**

<http://www.bosta.com>