

**Profec Nr. 40 Bocht 45°
gietijzer gegalvaniseerd 1 1/4"
binnendraad x buitendraad
25bar DVGW (1004006)**



TECHNISCHE SPECIFICATIES

Materiaal	gietijzer
Oppervlaktebehandeling	gegalvaniseerd
Keurmerk	DVGW
Verbinding	binnendraad x buitendraad
Fitting nr.	Nr. 40
Temperatuurbereik	-20°C - 120°C
Werkdruk	25 bar
Maat	1 1/4"

AFMETINGEN

Cb-1	64 mm
Cb-2	64 mm
F-1	20 mm
F-2	25 mm
ØDi-1	1 1/4 "
ØDo-2	1 1/4 "
β	45 °

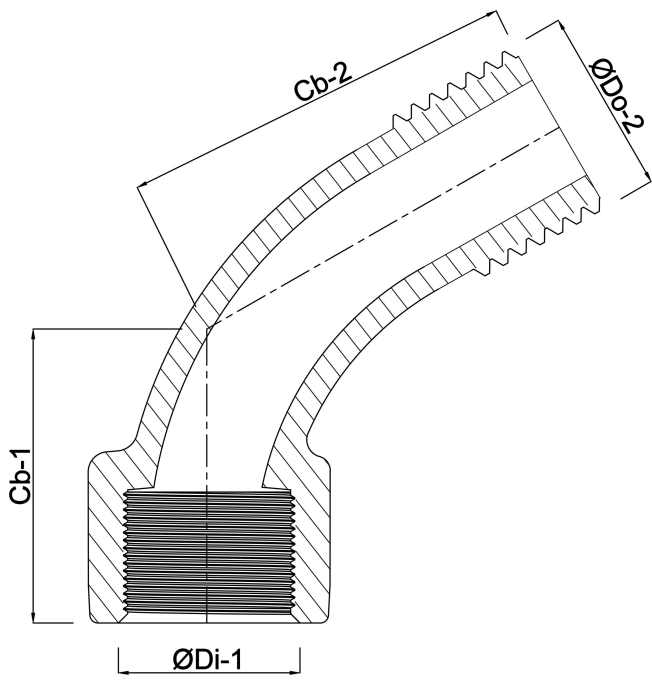

Gegenerereerd op datum: 13-03-2026

<http://www.bosta.com>