

**Profec Draadflens staal
verzinkt DN25 x 1" DIN flens x
binnendraad DN25 PN10/16
(1080212)**



TECHNISCHE SPECIFICATIES

Materiaal staal

Oppervlaktebehandeling verzinkt

Verbinding DIN flens x binnendraad

DIN Norm DIN 2566

Flens PN10/16

Maat DN25 x 1"

Bout

DN 25

Diameter 33,7 mm

Buiten ø 115 mm

Gewicht 1.1 kg

Dikte 16 mm

Boorgat 14 mm

Gaten 4

AFMETINGEN

O 14 mm

PCD

85 mm

ØDi-1

1 "

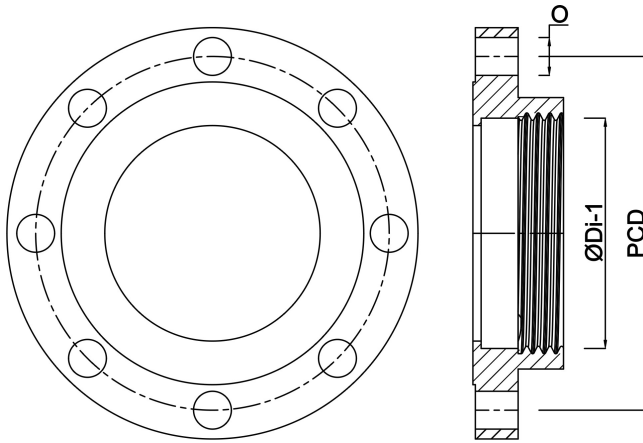

Gegeneerd op datum: 14-03-2026

<http://www.bosta.com>