

**Vlakke flens RVS 316 DN80 x
88,9 mm DIN flens x stomplas
10bar DN80 PN10/16 (0080637)**



TECHNISCHE SPECIFICATIES

Materiaal	RVS 316
Verbinding	DIN flens x stomplas
DIN Norm	DIN 2576
Werkdruk	10 bar
Maat	DN80 x 88,9 mm
DN	80
Binnen ø	90,5 mm
Flens	PN10/16
Diameter	88,9 mm
Buiten ø	200 mm
Gewicht	3.5 kg
Dikte	20 mm
Boorgat	18 mm
Gaten	8

AFMETINGEN

O	18 mm
---	-------

PCD

160 mm

ØDi-1

90.5 mm

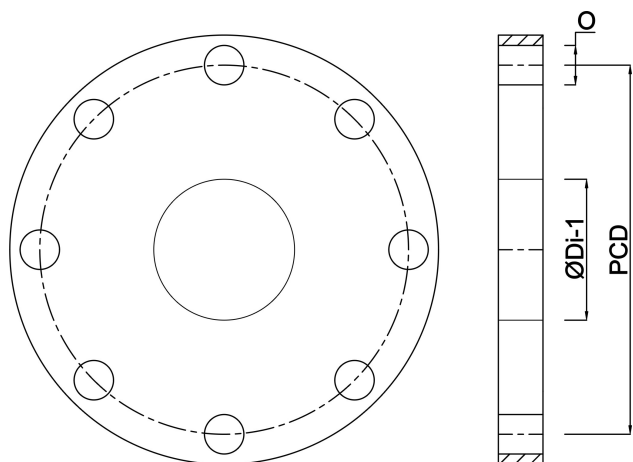

Gegenerereerd op datum: 28-05-2026

<http://www.bosta.com>