

Profec Vlakke flens staal DN40 x 48,3 mm DIN flens x stomplas 10bar PN10 (1180234)



TECHNISCHE SPECIFICATIES

Materiaal	staal
Verbinding	DIN flens x stomplas
DIN Norm	DIN 2576
Flens	PN10
Werkdruk	10 bar
Maat	DN40 x 48,3 mm
Binnen ø	49 mm
Buiten ø	150 mm
Gewicht	1.85 kg
Dikte	16 mm
Steekmaat	110 mm
Boorgat	18 mm
Gaten	4

AFMETINGEN

O	18 mm
PCD	110 mm

ØDi-1

49 mm

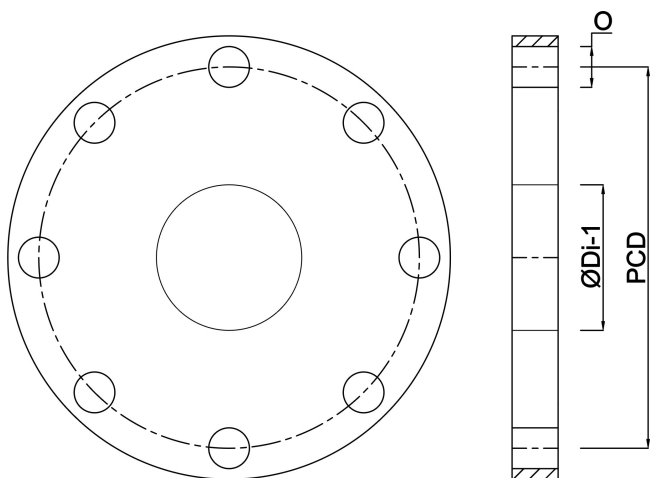

Gegenereerd op datum: 14-03-2026

<http://www.bosta.com>