

**Profec Nr. 40 Bocht 45°  
gietijzer gegalvaniseerd 3/4"  
binnendraad x buitendraad  
25bar DVGW (1004004)**



# TECHNISCHE SPECIFICATIES

Materiaal	gietijzer
Oppervlaktebehandeling	gegalvaniseerd
Keurmerk	DVGW
Verbinding	binnendraad x buitendraad
Fitting nr.	Nr. 40
Temperatuurbereik	-20°C - 120°C
Werkdruk	25 bar
Maat	3/4"

# AFMETINGEN

Cb-1	43 mm
Cb-2	43 mm
F-1	18 mm
F-2	18 mm
ØDi-1	3/4 "
ØDo-2	3/4 "
β	45 °

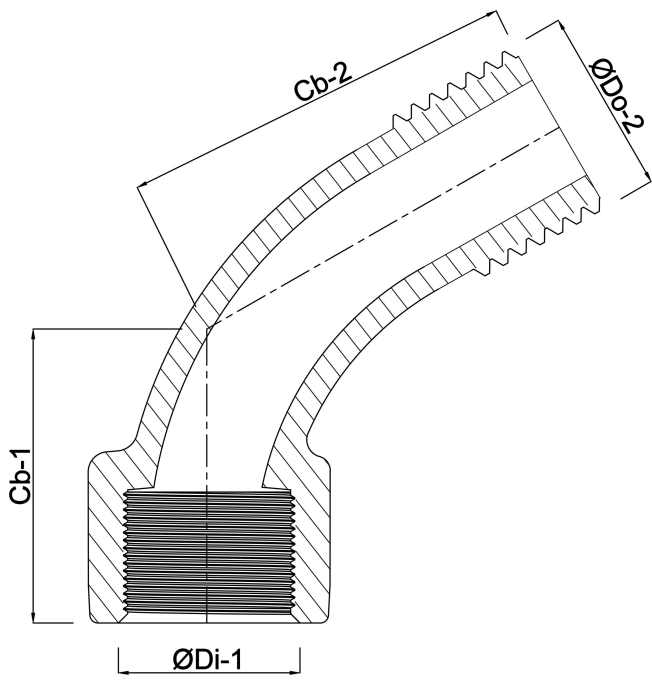

**Gegenerereerd op datum: 13-03-2026**

<http://www.bosta.com>