

**Bocht 90° staal 200 mm x 200
mm x 2,0 mm stomplas**
(0220616)



TECHNISCHE SPECIFICATIES

Materiaal staal

Verbinding stomplas

Wand 2,0 mm

Maat 200 mm

AFMETINGEN

Cb-1 325 mm

Cb-2 325 mm

ØDo-1 200 mm

ØDo-2 200 mm

β 90 °

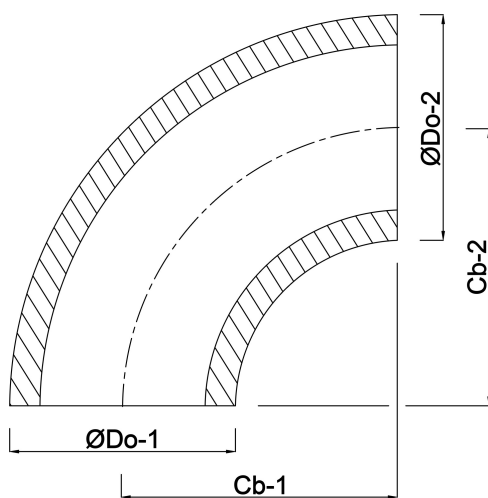

Gegenerereerd op datum: 14-03-2026

<http://www.bosta.com>