

Profec Nr. 121 Knie 45° RVS 316
3/8" binnendraad x
buitendraad 10bar (0081242)



TECHNISCHE SPECIFICATIES

Materiaal	RVS 316
Verbinding	binnendraad x buitendraad
Fitting nr.	Nr. 121
Werkdruk	10 bar
Maat	3/8"

AFMETINGEN

Cb-1	18 mm
Cb-2	30 mm
ØDi-1	3/8 "
ØDo-2	3/8 "
β	45 °

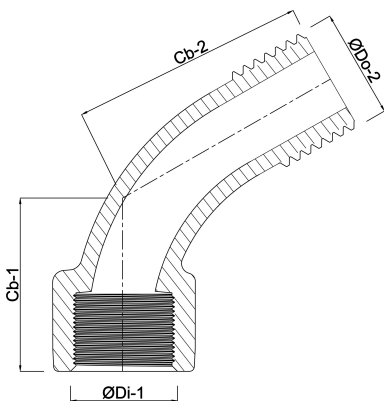

Gegenerereerd op datum: 13-03-2026

<http://www.bosta.com>