

Profec Vlakke flens staal DN32 x 42,4 mm DIN flens x stomplas 10bar PN10 (1180233)



TECHNISCHE SPECIFICATIES

Materiaal	staal
Verbinding	DIN flens x stomplas
DIN Norm	DIN 2576
Flens	PN10
Werkdruk	10 bar
Maat	DN32 x 42,4 mm
Binnen ø	43,1 mm
Buiten ø	140 mm
Gewicht	1.62 kg
Dikte	16 mm
Steekmaat	100 mm
Boorgat	18 mm
Gaten	4

AFMETINGEN

O	18 mm
PCD	100 mm

ØDi-1

43.1 mm

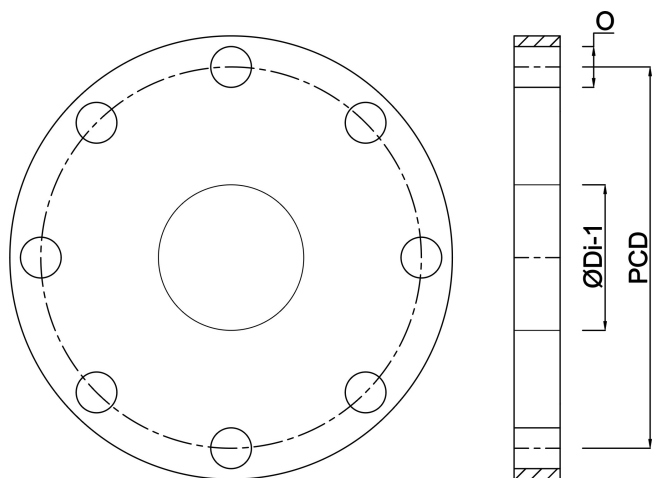

Gegeneerd op datum: 14-03-2026

<http://www.bosta.com>