

**Profec Draadflens staal  
verzinkt DN65 x 2 1/2" DIN  
flens x binnendraad DN65  
PN10/16 (1080216)**



# TECHNISCHE SPECIFICATIES

Materiaal                      staal

Oppervlaktebehandeling      verzinkt

Verbinding                      DIN flens x binnendraad

DIN Norm                        DIN 2566

Flens                              PN10/16

Maat                                DN65 x 2 1/2"

Bout

DN                                 65

Diameter                        76,1 mm

Buiten ø                         185 mm

Gewicht                         3.18 kg

Dikte                              18 mm

Boorgat                         18 mm

Gaten                              4

# AFMETINGEN

O                                  18 mm

PCD

145 mm

ØDi-1

2 1/2 "

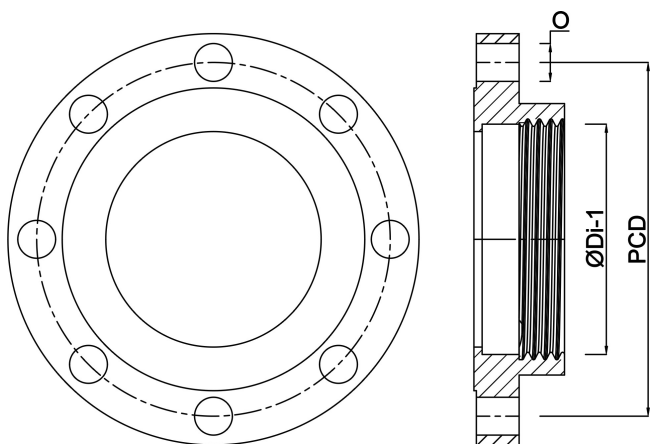

**Gegenerereerd op datum: 14-03-2026**

<http://www.bosta.com>