

**Profec Draadflens staal
verzinkt DN32 x 1 1/4" DIN
flens x binnendraad DN32
PN10/16 (1080213)**



TECHNISCHE SPECIFICATIES

Materiaal staal

Oppervlaktebehandeling verzinkt

Verbinding DIN flens x binnendraad

DIN Norm DIN 2566

Flens PN10/16

Maat DN32 x 1 1/4"

Bout

DN 32

Diameter 42,4 mm

Buiten ø 140 mm

Gewicht 1.6 kg

Dikte 16 mm

Boorgat 18 mm

Gaten 4

AFMETINGEN

O 18 mm

PCD

100 mm

ØDi-1

1 1/4 "

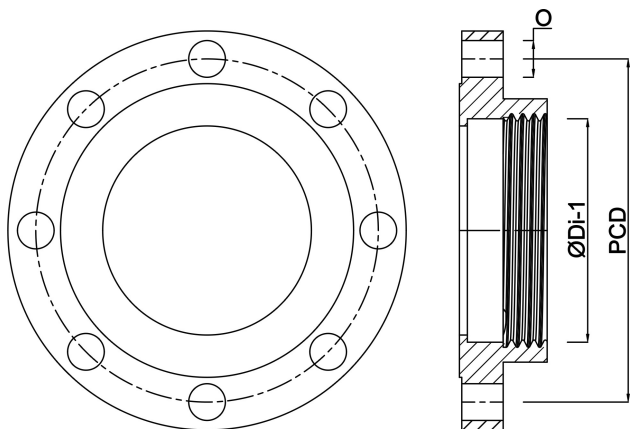

Gegeneerd op datum: 24-05-2026

<http://www.bosta.com>