

**Vlakke flens RVS 316 DN50 x
60,3 mm DIN flens x stomplas
10bar DN50 PN10/16 (0080635)**



TECHNISCHE SPECIFICATIES

Materiaal	RVS 316
Verbinding	DIN flens x stomplas
DIN Norm	DIN 2576
Werkdruk	10 bar
Maat	DN50 x 60,3 mm
DN	50
Binnen ø	61,5 mm
Flens	PN10/16
Diameter	60,3 mm
Buiten ø	165 mm
Gewicht	2.5 kg
Dikte	20 mm
Boorgat	18 mm
Gaten	4

AFMETINGEN

O	18 mm
---	-------

PCD 125 mm

ØDi-1 61.5 mm

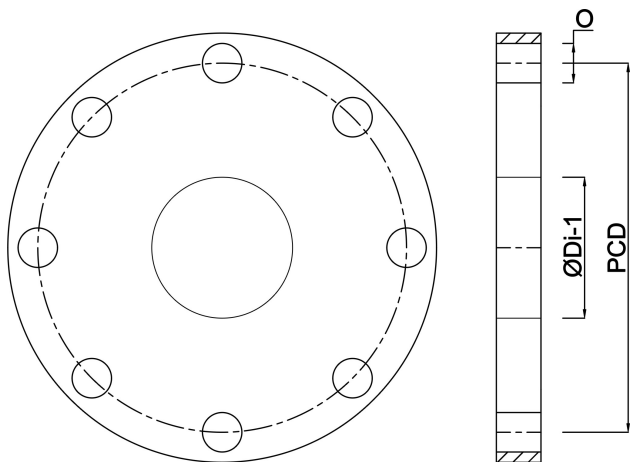

Gegenerereerd op datum: 22-05-2026

<http://www.bosta.com>