

Profec Vlakke flens staal DN25 x 33,7 mm DIN flens x stomplas 10bar PN10 (1180232)



TECHNISCHE SPECIFICATIES

Materiaal	staal
Verbinding	DIN flens x stomplas
DIN Norm	DIN 2576
Flens	PN10
Werkdruk	10 bar
Maat	DN25 x 33,7 mm
Binnen ø	34,4 mm
Buiten ø	115 mm
Gewicht	1.11 kg
Dikte	16 mm
Steekmaat	85 mm
Boorgat	14 mm
Gaten	4

AFMETINGEN

O	14 mm
PCD	85 mm

ØDi-1

34.1 mm

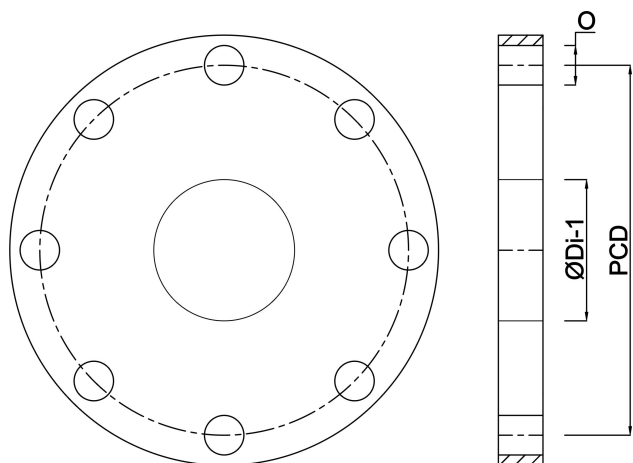

Gegeneerd op datum: 24-05-2026

<http://www.bosta.com>