

**Profec Nr. 956 Radiator
kniekoppeling 90° messing
3/4" binnendraad x
buitendraad 40bar type
conisch (0710432)**

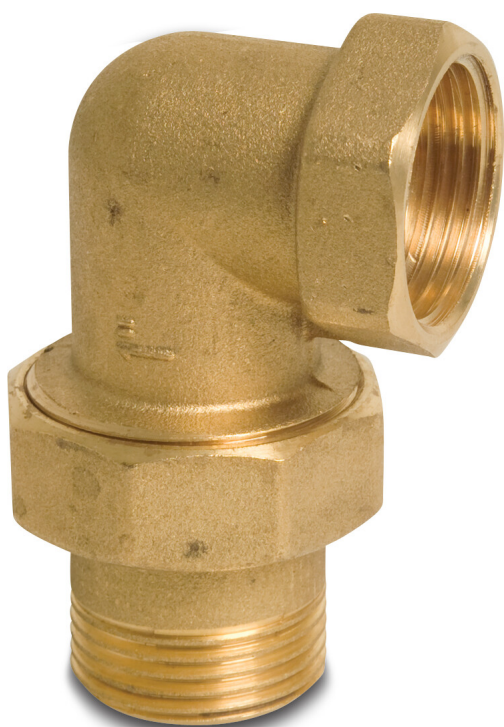

TECHNISCHE SPECIFICATIES

Type	conisch
Materiaal	messing
Verbinding	binnendraad x buitendraad
Fitting nr.	Nr. 956
Maat	3/4"
Werkdruk	40 bar

AFMETINGEN

Cb-1	25 mm
Cr-1	59 mm
ØDi-1	3/4 "
ØDo-1	3/4 "
β	90 °

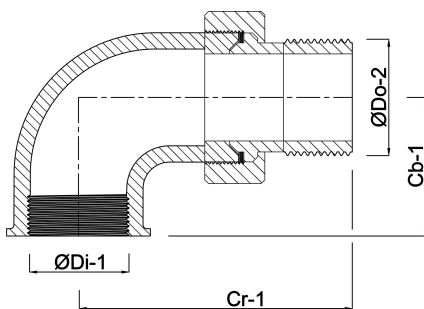

Gegenerereerd op datum: 13-03-2026

<http://www.bosta.com>