

**Profec Nr. 40 Bocht 45°
gietijzer gegalvaniseerd 3/8"
binnendraad x buitendraad
25bar DVGW (1004002)**



TECHNISCHE SPECIFICATIES

Materiaal	gietijzer
Oppervlaktebehandeling	gegalvaniseerd
Keurmerk	DVGW
Verbinding	binnendraad x buitendraad
Fitting nr.	Nr. 40
Temperatuurbereik	-20°C - 120°C
Werkdruk	25 bar
Maat	3/8"

AFMETINGEN

Cb-1	30 mm
Cb-2	30 mm
F-1	12 mm
F-2	12 mm
ØDi-1	3/8 "
ØDo-2	3/8 "
β	45 °

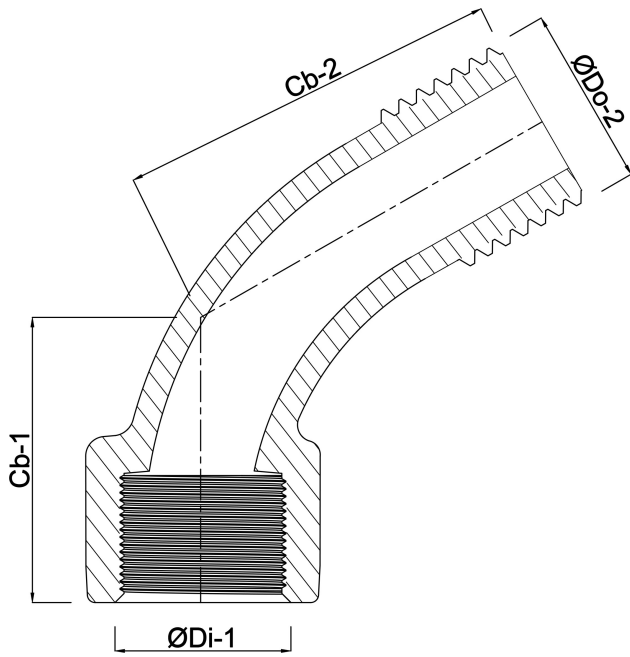

Gegeneroord op datum: 24-05-2026

<http://www.bosta.com>