

Profec Nr. 121 Knie 45° RVS 316
2" binnendraad x buitendraad
10bar (0081247)



TECHNISCHE SPECIFICATIES

Materiaal	RVS 316
Verbinding	binnendraad x buitendraad
Fitting nr.	Nr. 121
Werkdruk	10 bar
Maat	2"

AFMETINGEN

Cb-1	42 mm
Cb-2	65 mm
ØDi-1	2 "
ØDo-2	2 "
β	45 °

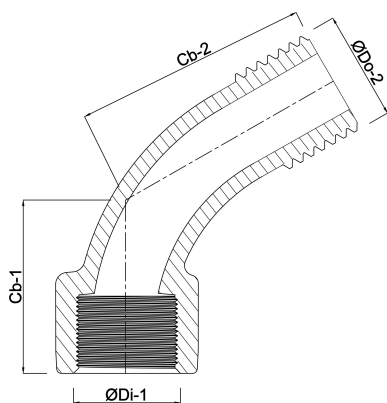

Gegenerereerd op datum: 13-03-2026

<http://www.bosta.com>