

# Profec Vlakke flens staal DN65 x 76,1 mm DIN flens x stomplas 10bar PN10 (1180236)



# TECHNISCHE SPECIFICATIES

Materiaal	staal
Verbinding	DIN flens x stomplas
DIN Norm	DIN 2576
Flens	PN10
Werkdruk	10 bar
Maat	DN65 x 76,1 mm
Binnen ø	77,1 mm
Buiten ø	185 mm
Gewicht	2.99 kg
Dikte	18 mm
Steekmaat	145 mm
Boorgat	18 mm
Gaten	4

# AFMETINGEN

O	18 mm
PCD	145 mm

ØDi-1

77.1 mm

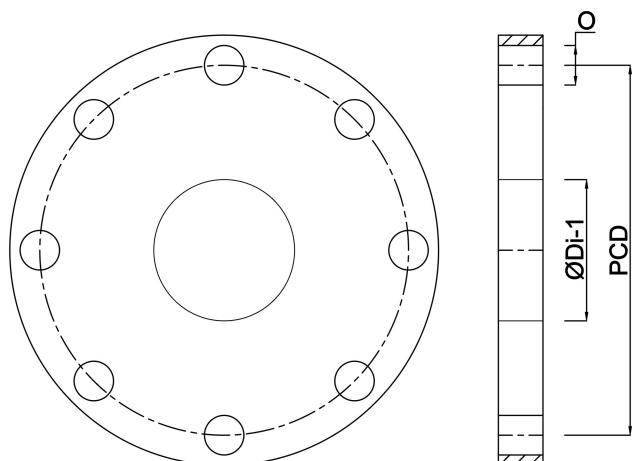

**Gegeneerd op datum: 24-05-2026**

<http://www.bosta.com>