

Profec Vlakke flens staal DN125 x 133,0 mm DIN flens x stomplas 10bar PN10 (1180242)



TECHNISCHE SPECIFICATIES

| | |
|------------|----------------------|
| Materiaal | staal |
| Verbinding | DIN flens x stomplas |
| DIN Norm | DIN 2576 |
| Flens | PN10 |
| Werkdruk | 10 bar |
| Maat | DN125 x 133,0 mm |
| Binnen ø | 134,8 mm |
| Buiten ø | 250 mm |
| Gewicht | 5.66 kg |
| Dikte | 22 mm |
| Steekmaat | 210 mm |
| Boorgat | 18 mm |
| Gaten | 8 |

AFMETINGEN

| | |
|-----|--------|
| O | 18 mm |
| PCD | 210 mm |

ØDi-1

134.8 mm

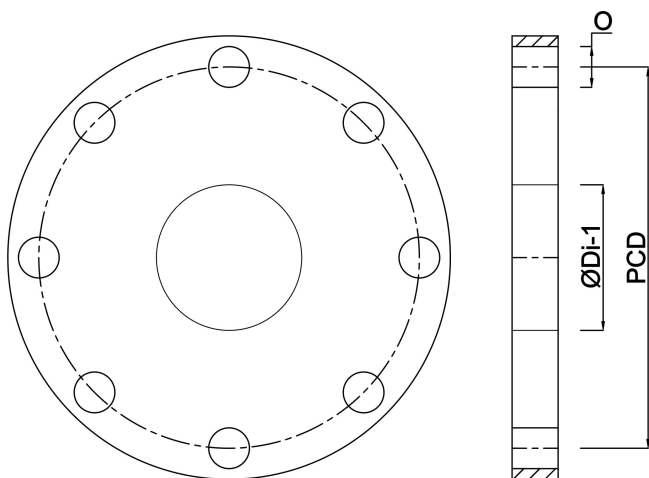

Gegenereerd op datum: 14-03-2026

<http://www.bosta.com>