

Profec Vlakke flens staal DN50 x 60,3 mm DIN flens x stomplas 10bar PN10 (1180235)



TECHNISCHE SPECIFICATIES

Materiaal	staal
Verbinding	DIN flens x stomplas
DIN Norm	DIN 2576
Flens	PN10
Werkdruk	10 bar
Maat	DN50 x 60,3 mm
Binnen ø	61,1 mm
Buiten ø	165 mm
Gewicht	2.46 kg
Dikte	18 mm
Steekmaat	125 mm
Boorgat	18 mm
Gaten	4

AFMETINGEN

O	18 mm
PCD	125 mm

ØDi-1

61.1 mm

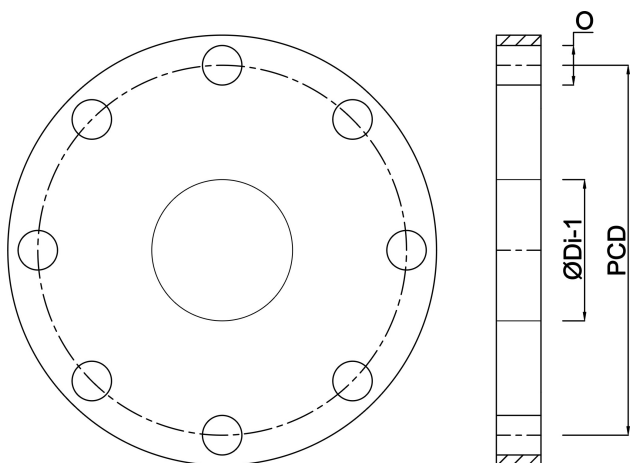

Gegeneerd op datum: 24-05-2026

<http://www.bosta.com>