

Knie 90° PP 3/4" binnendraad 10bar beige (0330402)



TECHNISCHE SPECIFICATIES

Kleur beige

Materiaal PP

Verbinding binnendraad

Werkdruk 10 bar

Maat 3/4"

AFMETINGEN

Cb-1 33 mm

Cb-2 33 mm

ØDi-1 3/4 "

ØDi-2 3/4 "

β 90 °

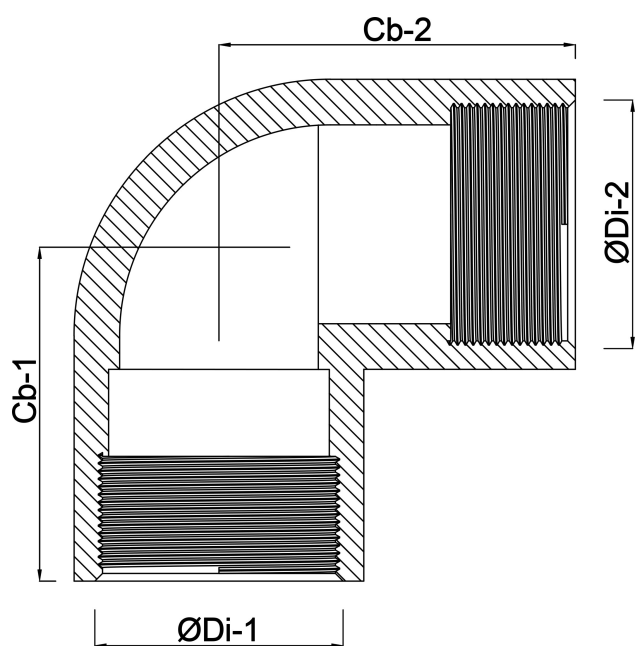

Gegeneerd op datum: 23-05-2026

<http://www.bosta.com>