

**Verloopsock PVC-U 315 mm x  
250 mm lijmstof 10bar grijs  
type handgevormd (0110691)**



# TECHNISCHE SPECIFICATIES

Kleur	grijs
Type	handgevormd
Materiaal	PVC-U
Verbinding	lijmmof
Werkdruk	10 bar
Maat	315 mm x 250 mm

# AFMETINGEN

L	510 mm
ØDi-1	315 mm
ØDi-2	250 mm

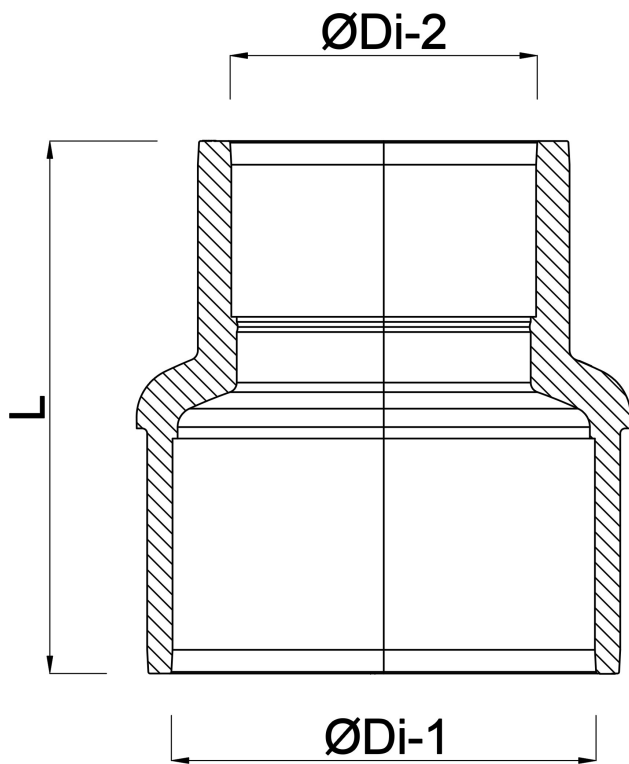

**Gegenerereerd op datum: 25-05-2026**

<http://www.bosta.com>