

VDL Koppeling PVC-U 3/4" x 25 mm binnendraad x lijmmof 10bar grijs type A (7002855)



V-L Van de Lande

TECHNISCHE SPECIFICATIES

Kleur	grijs
Type	A
Materiaal	PVC-U
Materiaal afdichting	EPDM
Verbinding	binnendraad x lijmmof
Maat	3/4" x 25 mm
Werkdruk	10 bar

AFMETINGEN

F-2	17 mm
L	61 mm
ØDi-1	25 mm
ØDi-2	3/4 "

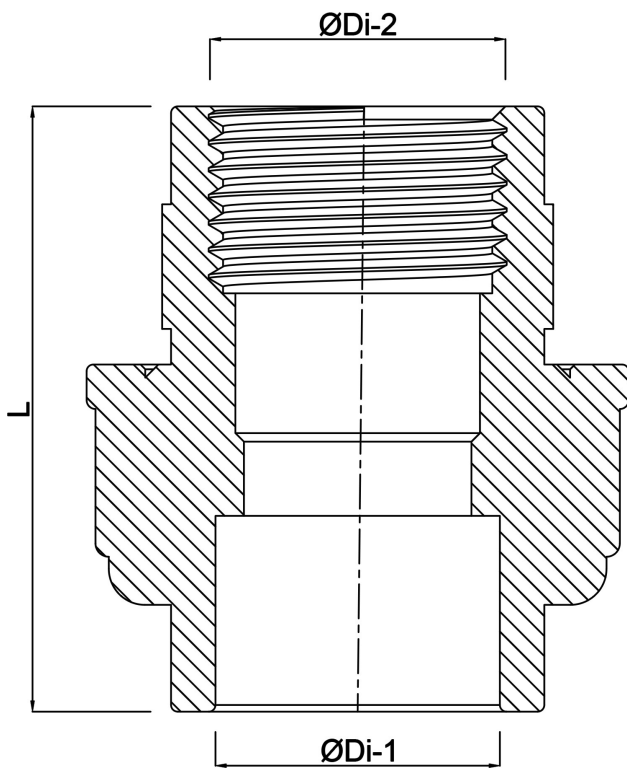

Gegenereerd op datum: 24-05-2026

<http://www.bosta.com>