

**Bocht 90° staal 150 mm x 150
mm x 2,0 mm stomplas**
(0200606)



TECHNISCHE SPECIFICATIES

Materiaal staal

Verbinding stomplas

Wand 2,0 mm

Maat 150 mm

AFMETINGEN

Cb-1 400 mm

Cb-2 400 mm

ØDo-1 150 mm

ØDo-2 150 mm

β 90 °

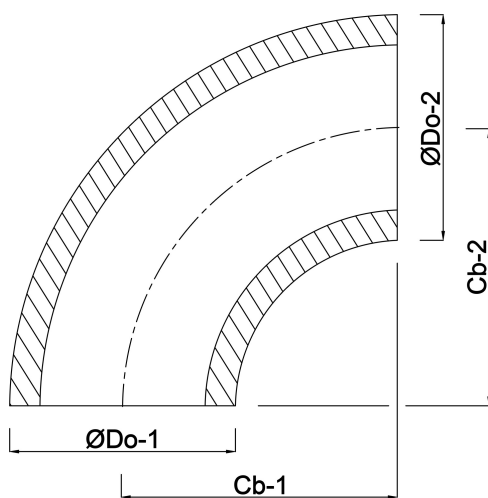

Gegenerereerd op datum: 14-03-2026

<http://www.bosta.com>