

**Profec Nr. 41 Bocht 45°
gietijzer gegalvaniseerd 1/2"
binnendraad 25bar DVGW
(1004103)**



TECHNISCHE SPECIFICATIES

Materiaal	gietijzer
Oppervlaktebehandeling	gegalvaniseerd
Keurmerk	DVGW
Verbinding	binnendraad
Fitting nr.	Nr. 41
Temperatuurbereik	-20°C - 120°C
Werkdruk	25 bar
Maat	1/2"

AFMETINGEN

Cb-1	36 mm
Cb-2	30 mm
ØDi-1	1/2 "
ØDi-2	1/2 "
β	45 °

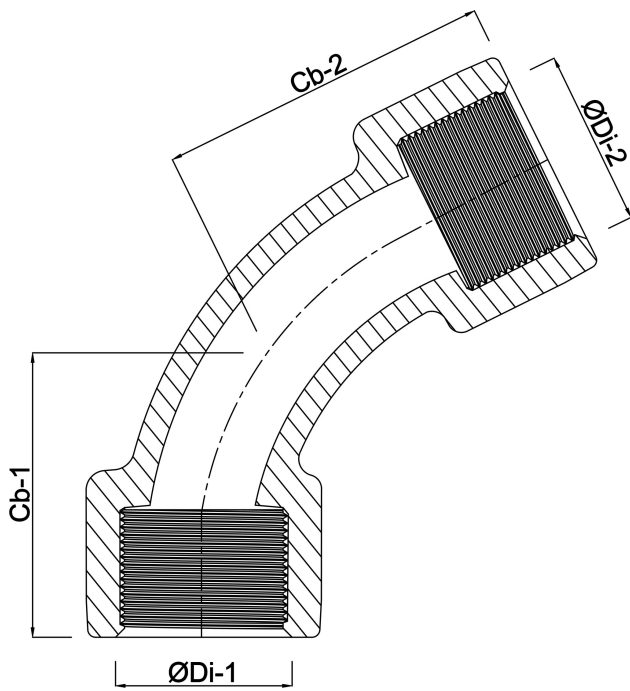

Gegeneerd op datum: 24-05-2026

<http://www.bosta.com>