

**Profec Nr. 290 Plug gietijzer
gegalvaniseerd 1/4"
buitendraad 25bar DVGW
(1029002)**



TECHNISCHE SPECIFICATIES

Materiaal	gietijzer
Oppervlaktebehandeling	gegalvaniseerd
Keurmerk	DVGW
Verbinding	buitendraad
Fitting nr.	Nr. 290
Temperatuurbereik	-20°C - 120°C
Werkdruk	25 bar
Maat	1/4"

AFMETINGEN

F-1	11 mm
H	22 mm
ØDo-1	1/4 "

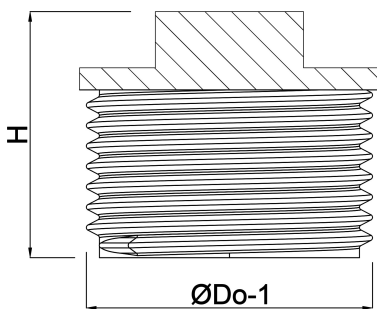

Gegenerereerd op datum: 14-03-2026

<http://www.bosta.com>