

VDL Verloopsock PVC-U 200 mm x 125 mm lijmstof 10bar grijs (7018290)

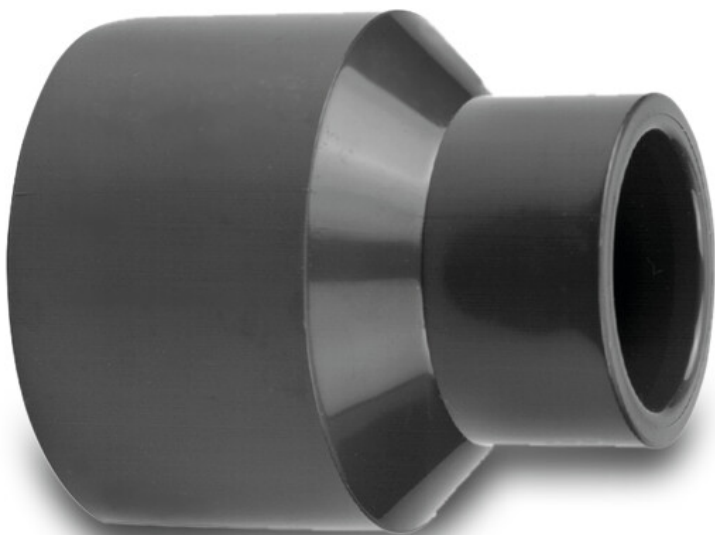

V-L Van de Lande

TECHNISCHE SPECIFICATIES

Kleur	grijs
Materiaal	PVC-U
Verbinding	lijmmof
Maat	200 mm x 125 mm
Werkdruk	10 bar

AFMETINGEN

L	236 mm
P-1	107 mm
P-2	69 mm
ØDi-1	200 mm
ØDi-2	125 mm



Gegenerereerd op datum: 25-05-2026

<http://www.bosta.com>