

Profec Koppeling PVC-U 1/2" binnendraad 10bar grijs (0100111)



TECHNISCHE SPECIFICATIES

Kleur grijs

Materiaal PVC-U

Verbinding binnendraad

Werkdruk 10 bar

Maat 1/2"

AFMETINGEN

Do-n 40 mm

Hi-1 20 mm

L 47 mm

Lb 27 mm

ØDi-1 1/2 "

ØDi-2 1/2 "

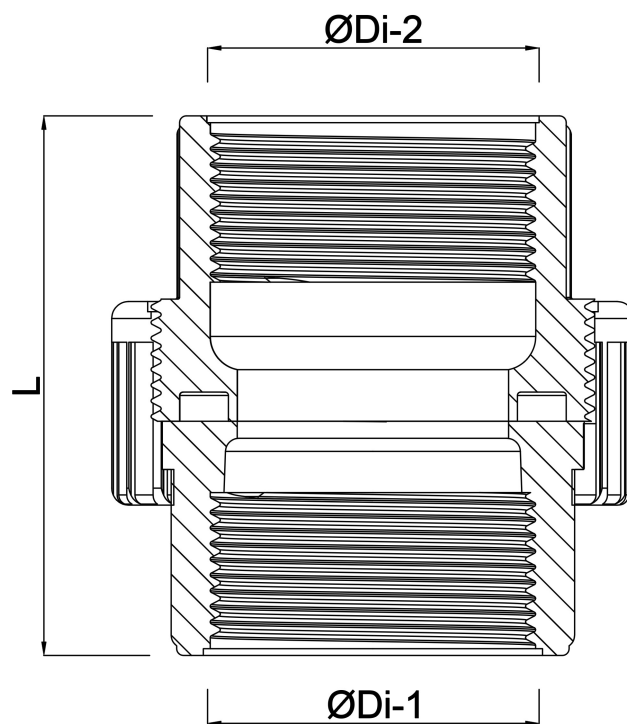

Gegenerereerd op datum: 22-05-2026

<http://www.bosta.com>