

Profec Nr. 41 Bocht 45°
gietijzer gegalvaniseerd 1 1/2"
binnendraad 25bar DVGW
(1004107)



TECHNISCHE SPECIFICATIES

Materiaal	gietijzer
Oppervlaktebehandeling	gegalvaniseerd
Keurmerk	DVGW
Verbinding	binnendraad
Fitting nr.	Nr. 41
Temperatuurbereik	-20°C - 120°C
Werkdruk	25 bar
Maat	1 1/2"

AFMETINGEN

Cb-1	68 mm
Cb-2	58 mm
ØDi-1	1 1/2 "
ØDi-2	1 1/2 "
β	45 °

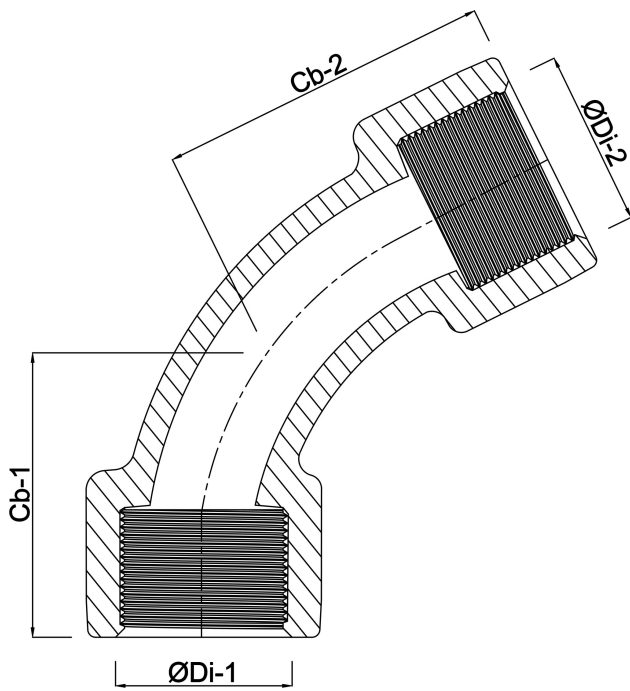

Gegenerereerd op datum: 24-05-2026

<http://www.bosta.com>