

Profec Vlakke flens staal DN150 x 159,0 mm DIN flens x stomplas 10bar PN10 (1180243)



TECHNISCHE SPECIFICATIES

Materiaal	staal
Verbinding	DIN flens x stomplas
DIN Norm	DIN 2576
Flens	PN10
Werkdruk	10 bar
Maat	DN150 x 159,0 mm
Binnen ø	161,1 mm
Buiten ø	285 mm
Gewicht	6.97 kg
Dikte	22 mm
Steekmaat	240 mm
Boorgat	22 mm
Gaten	8

AFMETINGEN

O	22 mm
PCD	240 mm

ØDi-1

161.1 mm

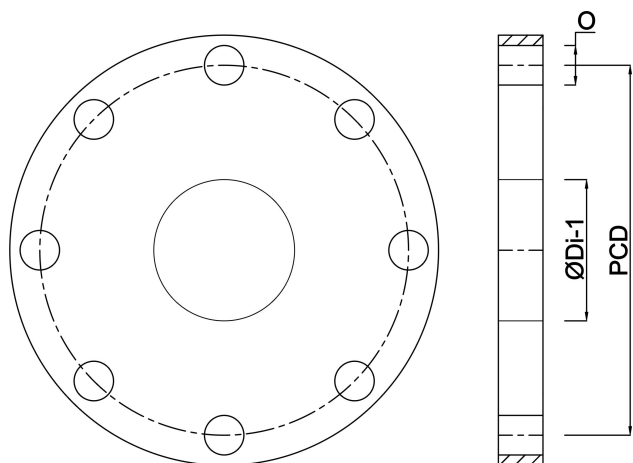

Gegeneerd op datum: 24-05-2026

<http://www.bosta.com>