

**Profec Draadflens staal
verzinkt DN15 x 1/2" DIN flens
x binnendraad DN15 PN10/16
(1080210)**



TECHNISCHE SPECIFICATIES

Materiaal staal

Oppervlaktebehandeling verzinkt

Verbinding DIN flens x binnendraad

DIN Norm DIN 2566

Flens PN10/16

Maat DN15 x 1/2"

Bout

DN 15

Diameter 21,3 mm

Buiten ø 95 mm

Gewicht 0.613 kg

Dikte 14 mm

Boorgat 14 mm

Gaten 4

AFMETINGEN

O 14 mm

PCD

65 mm

ØDi-1

1/2 "

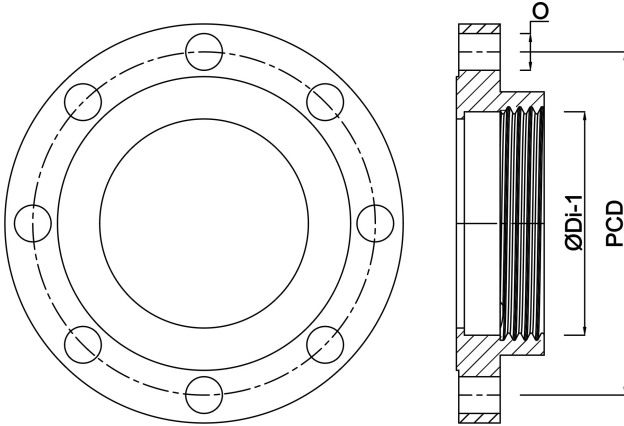

Gegenerereerd op datum: 24-05-2026

<http://www.bosta.com>